

# BELLATERRA HOME

## Model: 9901-MIRROR

### Tools List (Not included)



Tape Measure



Pencil



Electric Drill



Drill Bit

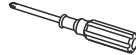

Screwdriver

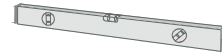

Spirit Level

### Parts List (Included)



Screw  
(2pcs)



Anchor  
(2pcs)

Mark the position of the screw holes on the wall by measuring the space between the mounting brackets on the back of the mirror. Vertical position (X) is decided by the use. Use a spirit level to ensure the screws holes are in line.

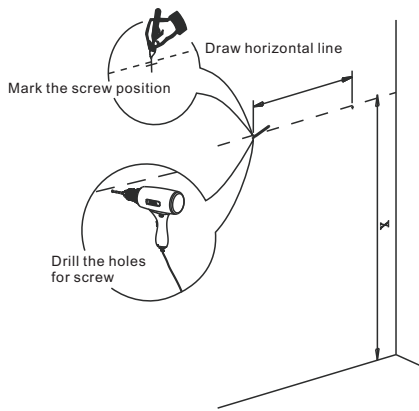

Step 1

Insert the anchor into the screw hole for reinforcement.

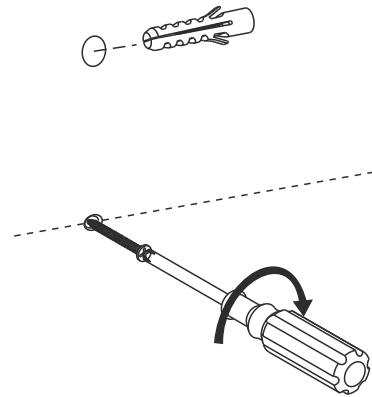

Step 2

Attach the mirror to the wall by lowering the bracket onto the screws.

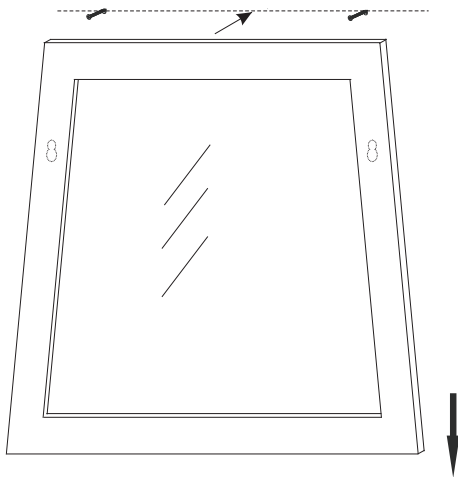

Step 3

Use a spirit level to ensure the mirror is level from left to right, adjust if needed. Licensed professional installation is recommended. These instructions are for mounting into studs or other in-wall reinforcement, drywall alone is not sufficient to support wall-hung vanities. Other installation techniques may require a licensed professional.

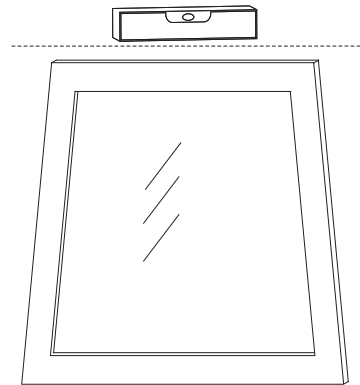

Step 4

### INSTALLATION TIPS:

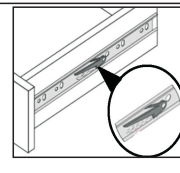
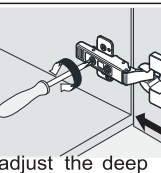
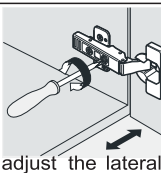
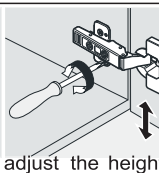
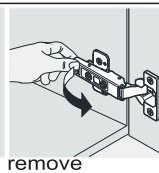
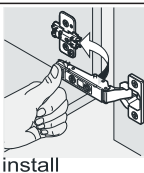

press down the pin on this side & press up the one on another side to pull out the drawer box.

**NOTE: SINK STYLE, SHAPE, FAUCET HOLES, CUTOUT ON TOP, VANITY MAY VARY FROM THE PICTURE ABOVE. INSTRUCTIONAL PURPOSE ONLY.**

Professional installation is recommended.  
www.bellaterra-home.com

Bellaterra Home LLC, All Rights Reserved 2016